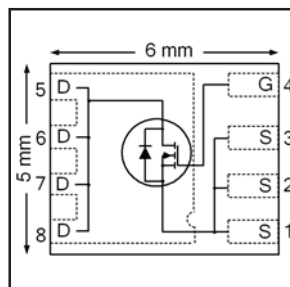


# IRFH5104PbF

HEXFET® Power MOSFET

$V_{DS}$	<b>40</b>	<b>V</b>
$R_{DS(on) max}$ (@ $V_{GS} = 10V$ )	<b>3.5</b>	<b>mΩ</b>
$Q_g$ (typical)	<b>53</b>	<b>nC</b>
$R_G$ (typical)	<b>1.4</b>	<b>Ω</b>
$I_D$ (@ $T_{c(Bottom)} = 25^\circ C$ )	<b>100</b> Ⓞ	<b>A</b>



## Applications

- Secondary Side Synchronous Rectification
- Inverters for DC Motors
- DC-DC Brick Applications
- Boost Converters

## Features and Benefits

### Features

Low $R_{DSon}$ ( $\leq 3.5m\Omega$ )
Low Thermal Resistance to PCB ( $\leq 1.1^\circ C/W$ )
100% $R_g$ tested
Low Profile ( $\leq 0.9$ mm)
Industry-Standard Pinout
Compatible with Existing Surface Mount Techniques
RoHS Compliant Containing no Lead, no Bromide and no Halogen
MSL1, Industrial Qualification

results in  
⇒

### Benefits

Lower Conduction Losses
Enables better thermal dissipation
Increased Reliability
Increased Power Density
Multi-Vendor Compatibility
Easier Manufacturing
Environmentally Friendlier
Increased Reliability

Orderable part number	Package Type	Standard Pack		Note
		Form	Quantity	
IRFH5104TRPBF	PQFN 5mm x 6mm	Tape and Reel	4000	
IRFH5104TR2PBF	PQFN 5mm x 6mm	Tape and Reel	1000	

## Absolute Maximum Ratings

	Parameter	Max.	Units
$V_{DS}$	Drain-to-Source Voltage	40	V
$V_{GS}$	Gate-to-Source Voltage	$\pm 20$	
$I_D @ T_A = 25^\circ C$	Continuous Drain Current, $V_{GS} @ 10V$	24	A
$I_D @ T_A = 70^\circ C$	Continuous Drain Current, $V_{GS} @ 10V$	19	
$I_D @ T_{c(Bottom)} = 25^\circ C$	Continuous Drain Current, $V_{GS} @ 10V$ Ⓞ	100	
$I_D @ T_{c(Bottom)} = 100^\circ C$	Continuous Drain Current, $V_{GS} @ 10V$	86	
$I_{DM}$	Pulsed Drain Current ①	400	
$P_D @ T_A = 25^\circ C$	Power Dissipation ⑤	3.6	W
$P_D @ T_{c(Bottom)} = 25^\circ C$	Power Dissipation ⑤	114	
	Linear Derating Factor ⑤	0.029	W/°C
$T_J$	Operating Junction and	-55 to + 150	°C
$T_{STG}$	Storage Temperature Range		

Notes ① through ⑥ are on page 8

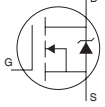
## Static @ $T_J = 25^\circ\text{C}$ (unless otherwise specified)

	Parameter	Min.	Typ.	Max.	Units	Conditions
$BV_{DSS}$	Drain-to-Source Breakdown Voltage	40	—	—	V	$V_{GS} = 0V, I_D = 250\mu A$
$\Delta BV_{DSS}/\Delta T_J$	Breakdown Voltage Temp. Coefficient	—	0.05	—	V/ $^\circ\text{C}$	Reference to $25^\circ\text{C}, I_D = 1mA$
$R_{DS(on)}$	Static Drain-to-Source On-Resistance	—	2.9	3.5	m $\Omega$	$V_{GS} = 10V, I_D = 50A$ ③
$V_{GS(th)}$	Gate Threshold Voltage	2.0	—	4.0	V	$V_{DS} = V_{GS}, I_D = 100\mu A$
$\Delta V_{GS(th)}$	Gate Threshold Voltage Coefficient	—	-8.9	—	mV/ $^\circ\text{C}$	
$I_{DSS}$	Drain-to-Source Leakage Current	—	—	20	$\mu A$	$V_{DS} = 40V, V_{GS} = 0V$
		—	—	250		$V_{DS} = 40V, V_{GS} = 0V, T_J = 125^\circ\text{C}$
$I_{GSS}$	Gate-to-Source Forward Leakage	—	—	100	nA	$V_{GS} = 20V$
	Gate-to-Source Reverse Leakage	—	—	-100		$V_{GS} = -20V$
gfs	Forward Transconductance	56	—	—	S	$V_{DS} = 15V, I_D = 50A$
$Q_g$	Total Gate Charge	—	53	80	nC	$V_{DS} = 20V$ $V_{GS} = 10V$ $I_D = 50A$ See Fig.17 & 18
$Q_{gs1}$	Pre-Vth Gate-to-Source Charge	—	10	—		
$Q_{gs2}$	Post-Vth Gate-to-Source Charge	—	4.8	—		
$Q_{gd}$	Gate-to-Drain Charge	—	19	—		
$Q_{godr}$	Gate Charge Overdrive	—	19.2	—		
$Q_{sw}$	Switch Charge ( $Q_{gs2} + Q_{gd}$ )	—	23.8	—		
$Q_{oss}$	Output Charge	—	22	—	nC	$V_{DS} = 16V, V_{GS} = 0V$
$R_G$	Gate Resistance	—	1.4	—	$\Omega$	
$t_{d(on)}$	Turn-On Delay Time	—	9.5	—	ns	$V_{DD} = 20V, V_{GS} = 10V$ $I_D = 50A$ $R_G = 1.7\Omega$ See Fig.15
$t_r$	Rise Time	—	15	—		
$t_{d(off)}$	Turn-Off Delay Time	—	20	—		
$t_f$	Fall Time	—	10	—		
$C_{iss}$	Input Capacitance	—	3120	—	pF	$V_{GS} = 0V$ $V_{DS} = 25V$ $f = 1.0MHz$
$C_{oss}$	Output Capacitance	—	650	—		
$C_{rss}$	Reverse Transfer Capacitance	—	310	—		

## Avalanche Characteristics

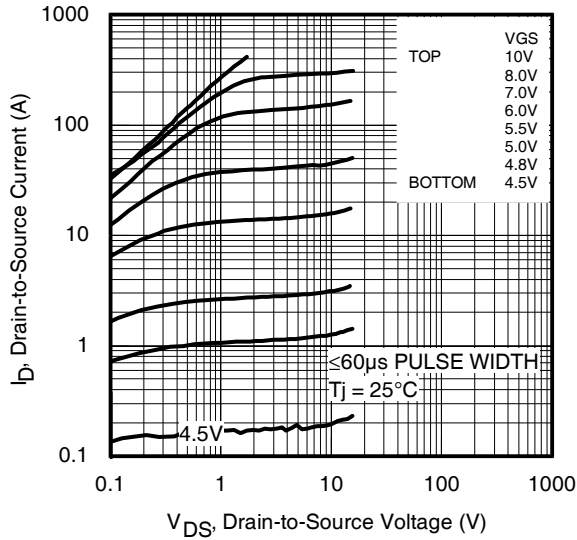
	Parameter	Typ.	Max.	Units
$E_{AS}$	Single Pulse Avalanche Energy ②	—	120	mJ
$I_{AR}$	Avalanche Current ①	—	50	A

## Diode Characteristics

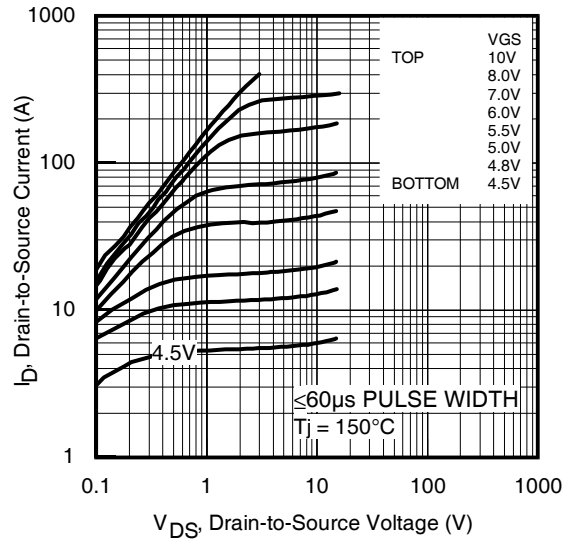
	Parameter	Min.	Typ.	Max.	Units	Conditions
$I_S$	Continuous Source Current (Body Diode) ⑥	—	—	100	A	MOSFET symbol showing the integral reverse p-n junction diode. 
$I_{SM}$	Pulsed Source Current (Body Diode) ①	—	—	400		
$V_{SD}$	Diode Forward Voltage	—	—	1.3	V	$T_J = 25^\circ\text{C}, I_S = 50A, V_{GS} = 0V$ ③
$t_{rr}$	Reverse Recovery Time	—	31	47	ns	$T_J = 25^\circ\text{C}, I_F = 50A, V_{DD} = 20V$
$Q_{rr}$	Reverse Recovery Charge	—	130	195	nC	$di/dt = 500A/\mu s$ ③
$t_{on}$	Forward Turn-On Time	Time is dominated by parasitic Inductance				

## Thermal Resistance

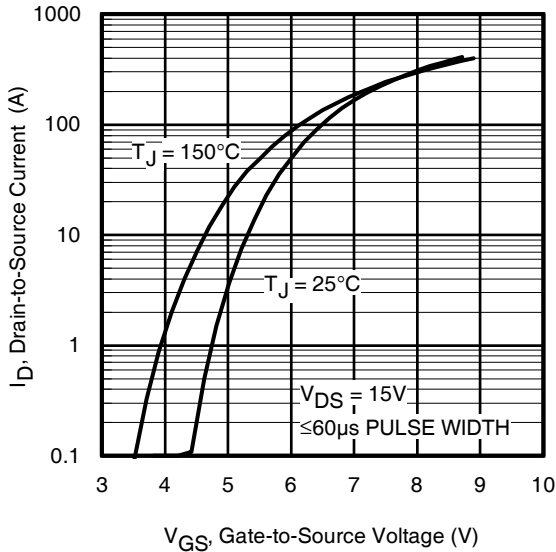
	Parameter	Typ.	Max.	Units
$R_{\theta JC}$ (Bottom)	Junction-to-Case ④	—	1.1	$^\circ\text{C/W}$
$R_{\theta JC}$ (Top)	Junction-to-Case ④	—	15	
$R_{\theta JA}$	Junction-to-Ambient ⑤	—	35	
$R_{\theta JA}$ (<10s)	Junction-to-Ambient ⑤	—	22	



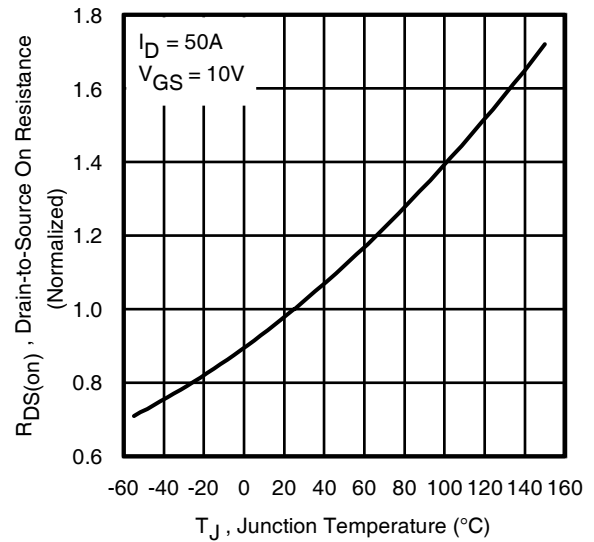
**Fig 1.** Typical Output Characteristics



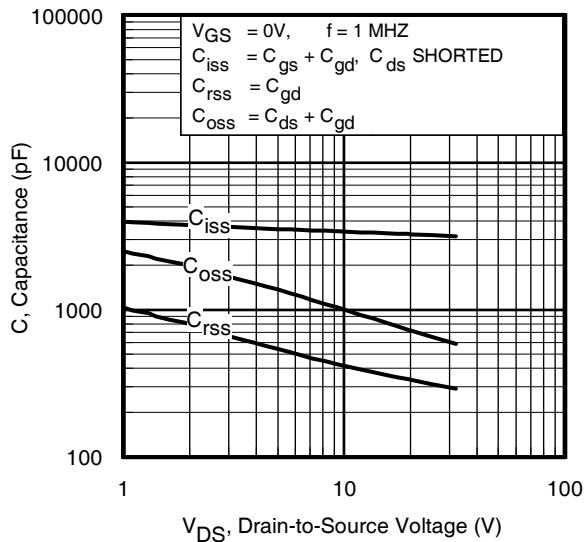
**Fig 2.** Typical Output Characteristics



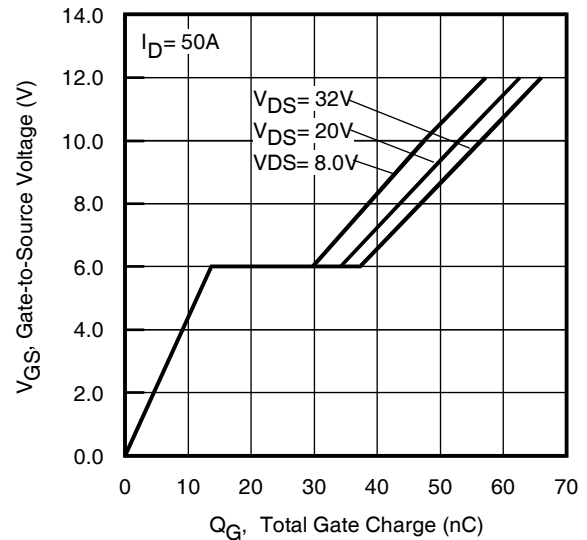
**Fig 3.** Typical Transfer Characteristics



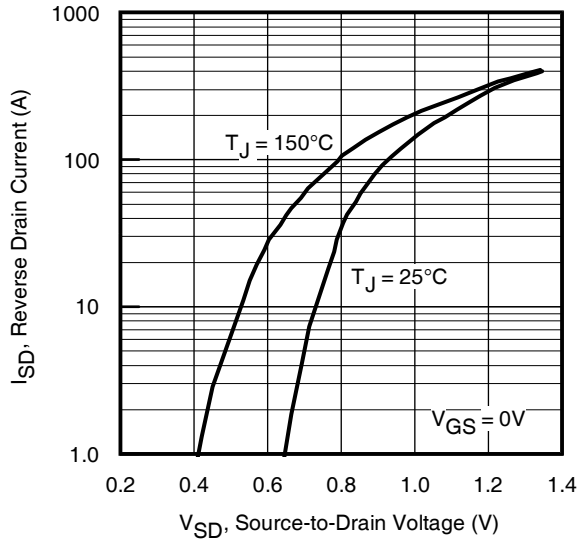
**Fig 4.** Normalized On-Resistance vs. Temperature



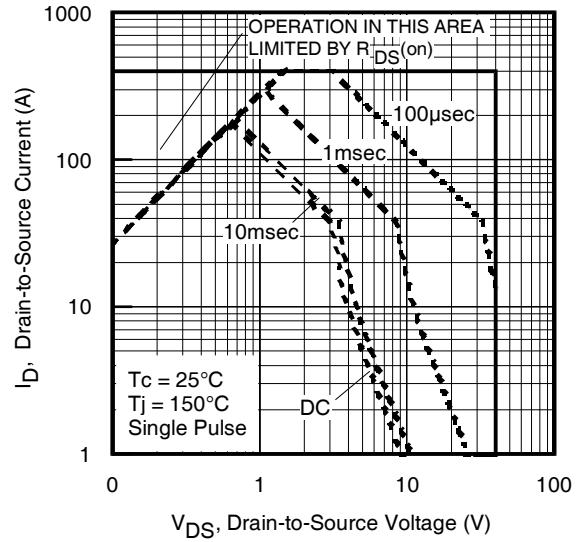
**Fig 5.** Typical Capacitance vs. Drain-to-Source Voltage  
[www.irf.com](http://www.irf.com)



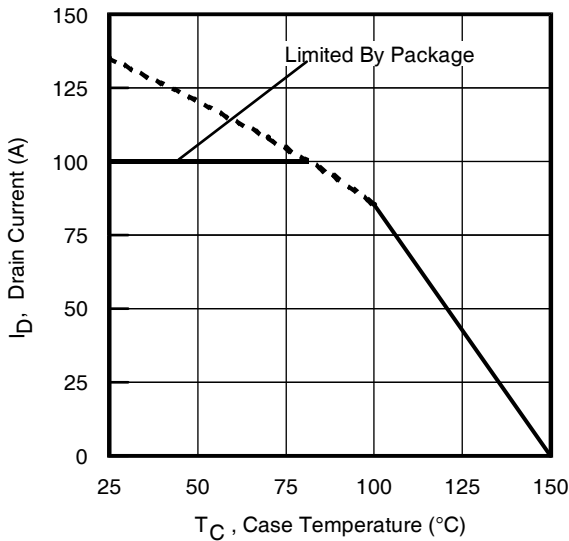
**Fig 6.** Typical Gate Charge vs. Gate-to-Source Voltage



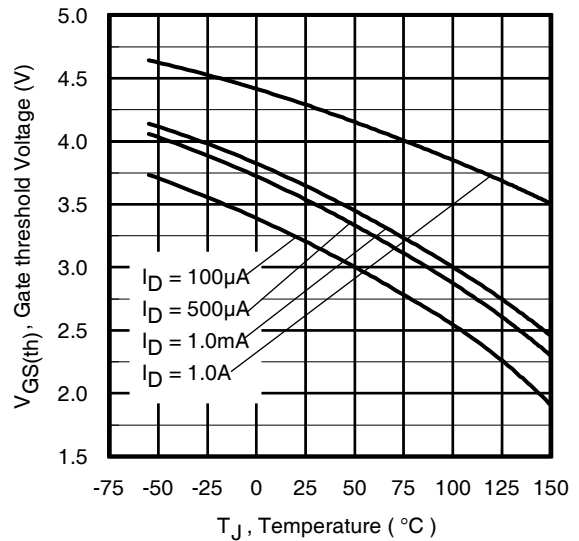
**Fig 7.** Typical Source-Drain Diode Forward Voltage



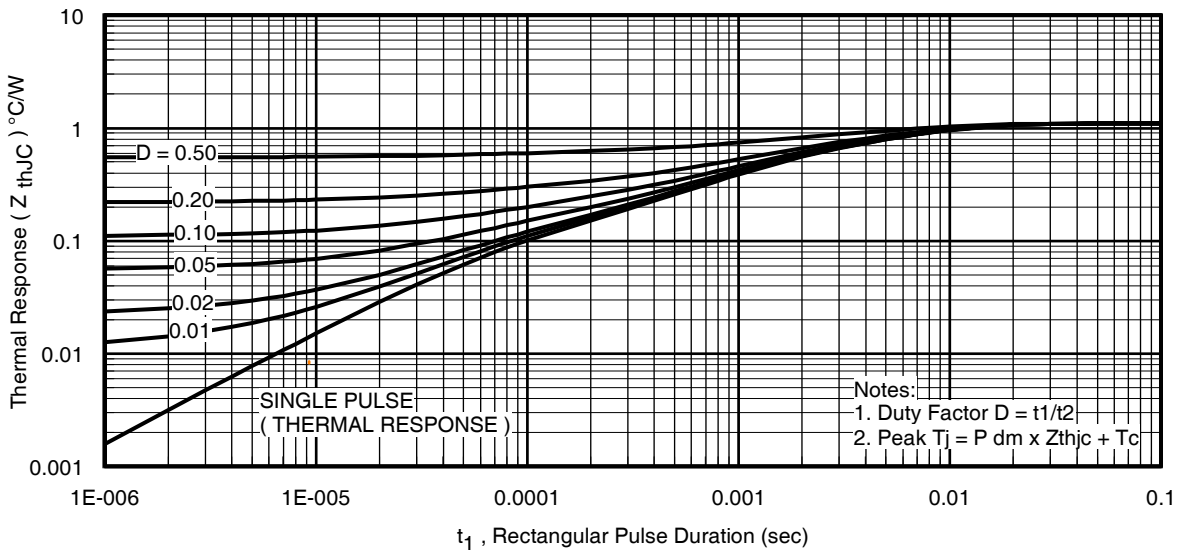
**Fig 8.** Maximum Safe Operating Area



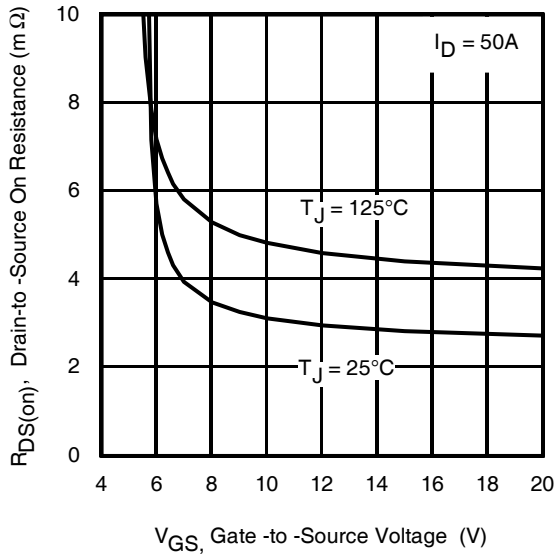
**Fig 9.** Maximum Drain Current vs. Case (Bottom) Temperature



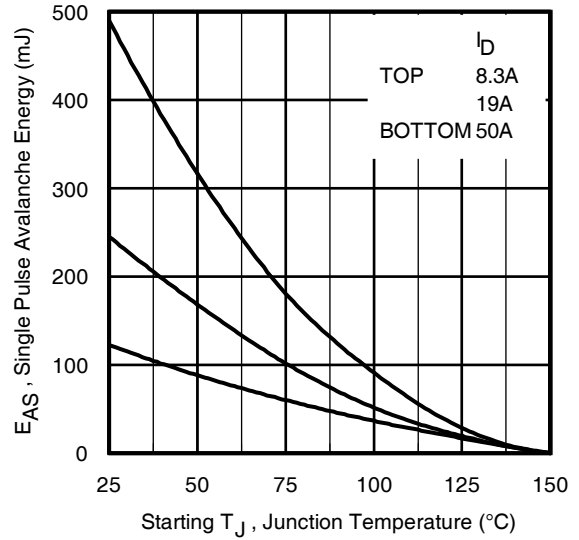
**Fig 10.** Threshold Voltage vs. Temperature



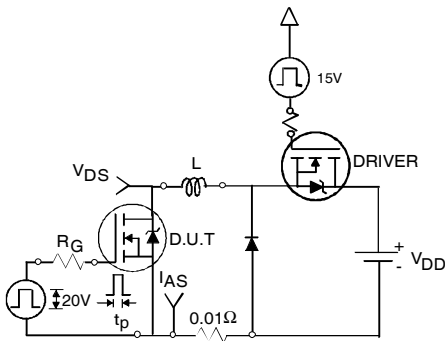
**Fig 11.** Maximum Effective Transient Thermal Impedance, Junction-to-Case (Bottom)



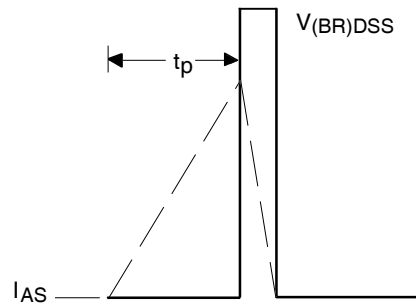
**Fig 12.** On-Resistance vs. Gate Voltage



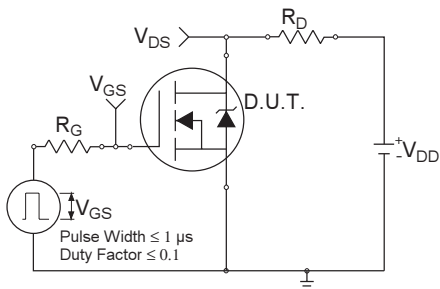
**Fig 13.** Maximum Avalanche Energy vs. Drain Current



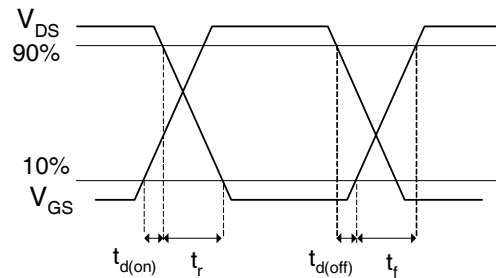
**Fig 14a.** Unclamped Inductive Test Circuit



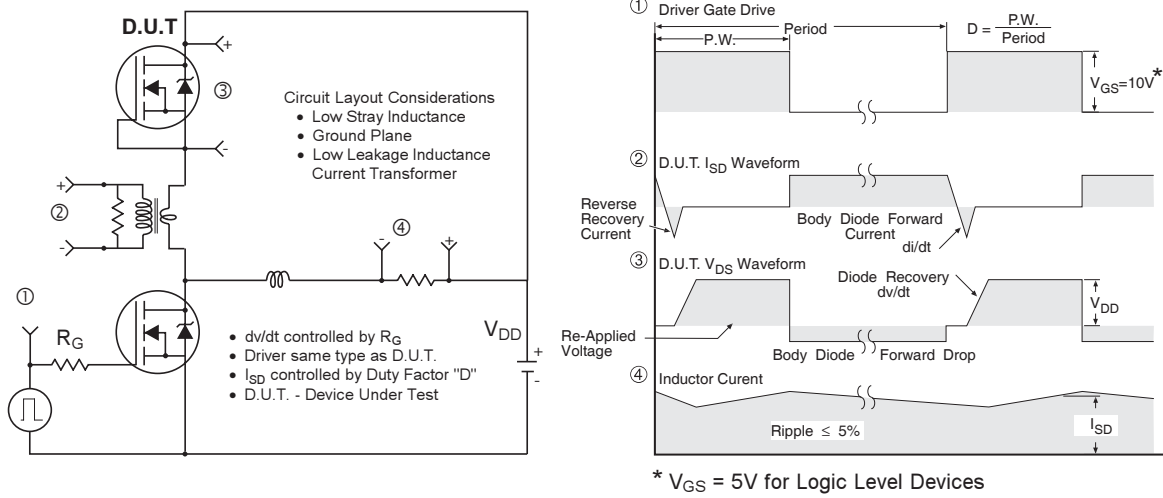
**Fig 14b.** Unclamped Inductive Waveforms



**Fig 15a.** Switching Time Test Circuit



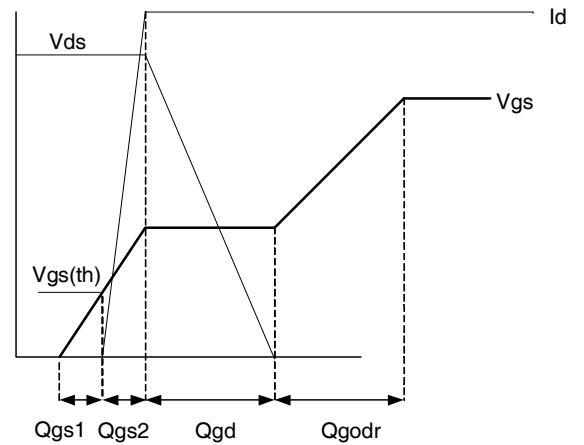
**Fig 15b.** Switching Time Waveforms



**Fig 16. Peak Diode Recovery  $dv/dt$  Test Circuit for N-Channel HEXFET<sup>®</sup> Power MOSFETs**

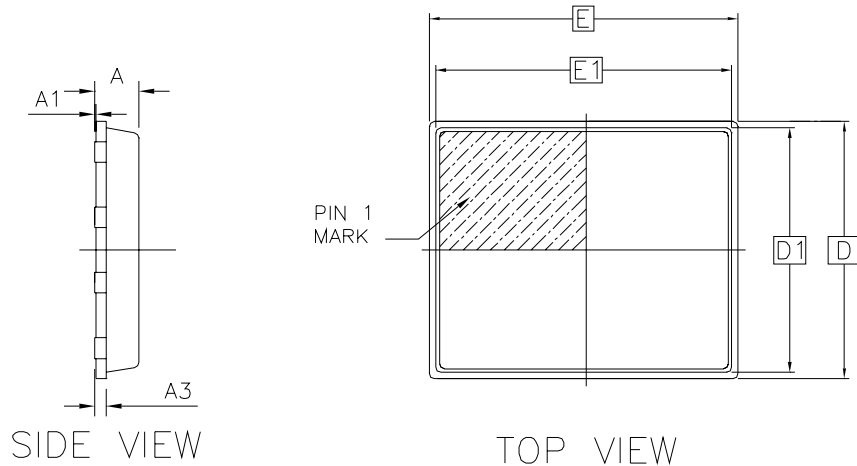


**Fig 17. Gate Charge Test Circuit**

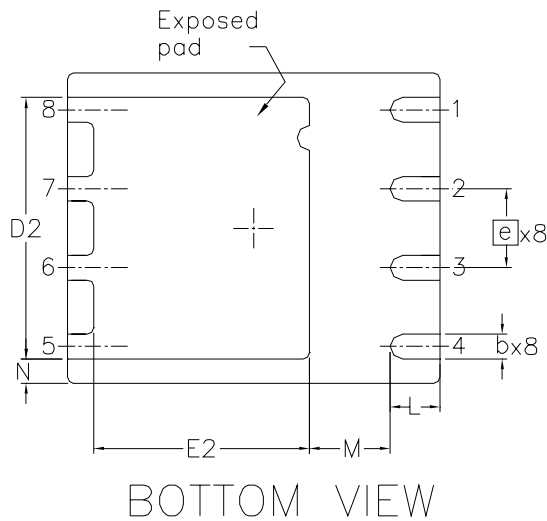


**Fig 18. Gate Charge Waveform**

### PQFN 5x6 Outline "B" Package Details

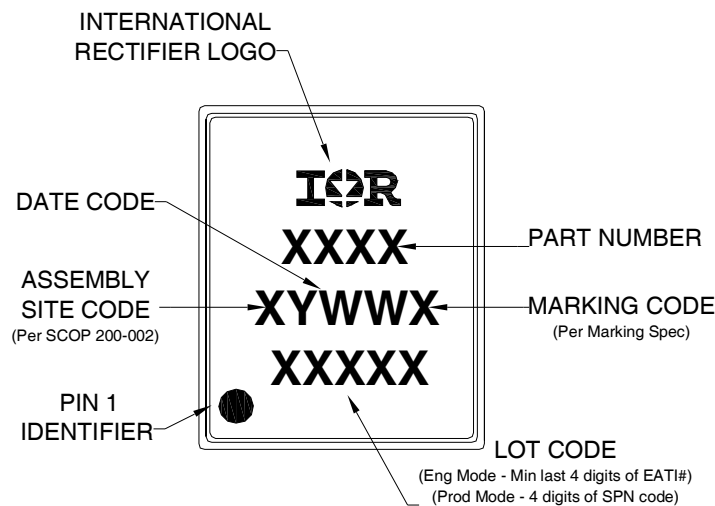


OUTLINE PQFN 5x6B			
DIM SYMBOL	MIN	NOM	MAX
A	0.80	0.83	0.90
A1	0	0.020	0.05
A3		0.20	REF
b	0.35	0.40	0.47
D		5.00	BSC
D1		4.75	BSC
D2	4.10	4.21	4.30
e		1.27	BSC
E		6.00	BSC
E1		5.75	BSC
E2	3.38	3.48	3.58
L	0.70	0.80	0.90
M		1.30	REF
N		0.40	REF



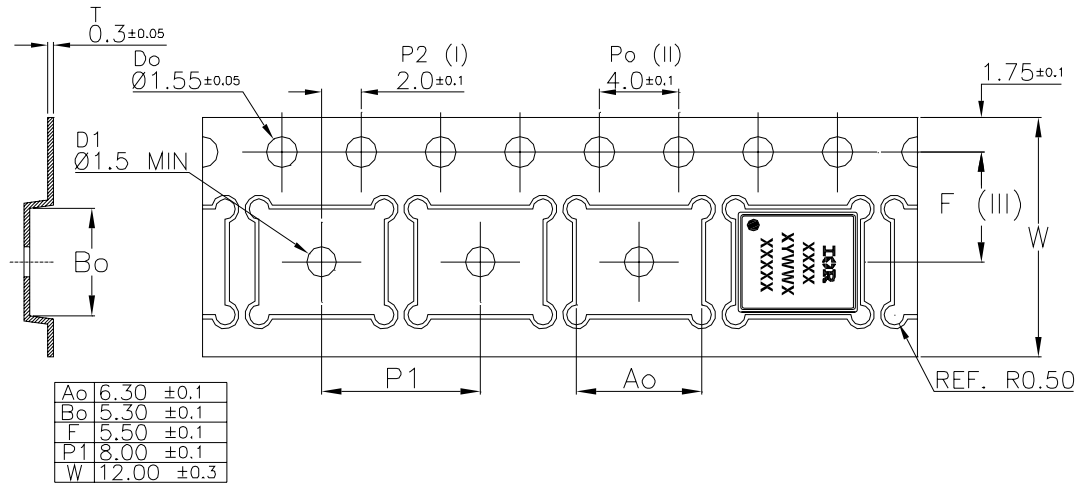
For footprint and stencil design recommendations, please refer to application note AN-1154 at <http://www.irf.com/technical-info/apnotes/an-1154.pdf>

### PQFN 5x6 Outline "B" Part Marking



Note: For the most current drawing please refer to IR website at: <http://www.irf.com/package/>  
[www.irf.com](http://www.irf.com)

## PQFN 5x6 Outline "B" Tape and Reel



### Qualification information<sup>†</sup>

Qualification level	Industrial <sup>††</sup> (per JEDEC JESD47F <sup>†††</sup> guidelines)	
Moisture Sensitivity Level	PQFN 5mm x 6mm	MSL1 (per JEDEC J-STD-020D <sup>†††</sup> )
RoHS compliant	Yes	

<sup>†</sup> Qualification standards can be found at International Rectifier's web site

<http://www.irf.com/product-info/reliability>

<sup>††</sup> Higher qualification ratings may be available should the user have such requirements.

Please contact your International Rectifier sales representative for further information:

<http://www.irf.com/whoto-call/salesrep/>

<sup>†††</sup> Applicable version of JEDEC standard at the time of product release.

### Notes:

- ① Repetitive rating; pulse width limited by max. junction temperature.
- ② Starting  $T_J = 25^\circ\text{C}$ ,  $L = 0.098\text{mH}$ ,  $R_G = 25\Omega$ ,  $I_{AS} = 50\text{A}$ .
- ③ Pulse width  $\leq 400\mu\text{s}$ ; duty cycle  $\leq 2\%$ .
- ④  $R_\theta$  is measured at  $T_J$  of approximately  $90^\circ\text{C}$ .
- ⑤ When mounted on 1 inch square 2 oz copper pad on 1.5x1.5 in. board of FR-4 material.
- ⑥ Calculated continuous current based on maximum allowable junction temperature. Package is limited to 100A by production test capability.

Data and specifications subject to change without notice.

International  
**IR** Rectifier

IR WORLD HEADQUARTERS: 233 Kansas St., El Segundo, California 90245, USA Tel: (310) 252-7105

TAC Fax: (310) 252-7903

Visit us at [www.irf.com](http://www.irf.com) for sales contact information. 01/2011